

DESCRIPTION

Spy adjustable projector integrates easily into gardens, facades and pergola, compact, and with minimal shapes give high lighting performances in different dimensions.

TRIDONIC

Driver



CREE

LED Chip



Illumination Data

Color temperature:	3000K 4000K 6500K
Lumen output:	1000 LM 1500LM 2000LM 2500 LM
CRI	80
Beam angle	15° Spot 24° Narrow 38° Medium 45° Wide 60° Extra wide

Physical Specification

Material Finish	Die cast aluminium
Diffuser	Tempered Glass
Optics	LENS
Ingress protection (IP)	65
Impact Protection (IK)	08

Electric Characteristics

Light source	LED Built in
LED type	COB
Power	10 Watt 15 Watt 20 Watt 25 Watt
P.F	>0.9
LED chip	Cree
Driver	Meanwell Tridonic

Installation

Installation	Ground Surface
Wiring	Product complete with electronic components

Luminaire Body Finish Color

White Ral 9003	
Grey Ral 9006	
Black Ral 9005	

Certificate & Warranty

Certification	CB CE LM79 LM80 TM21 Photo biological
Lifetime expectancy	50.000 hrs
Warranty duration	Up to 5 years

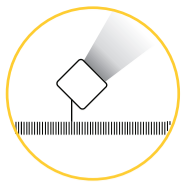

Dimensions & Specs

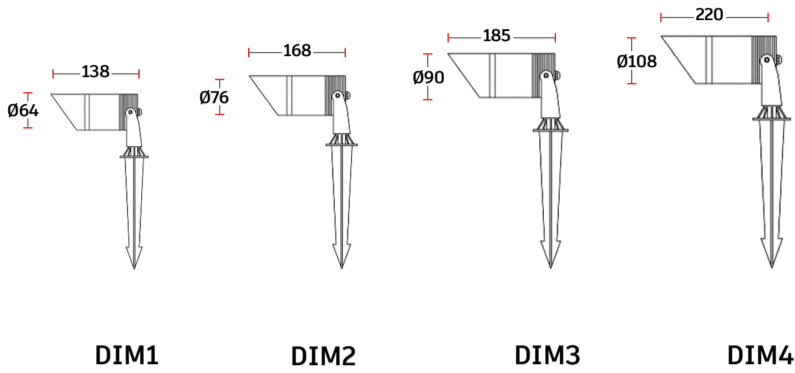

All dimensions in these sketches are in millimeters

Dimensions & specs of luminaires

Dim	Diameter	Length	Watt	Lumen
1	64mm	138mm	10	1000
2	76mm	168mm	15	1500
3	90mm	185mm	20	2000
4	108mm	220mm	25	2500

All dimensions in this schedule table are in millimeters

Product coding system

BR - SP X X XX.8 XX X 65 X - X

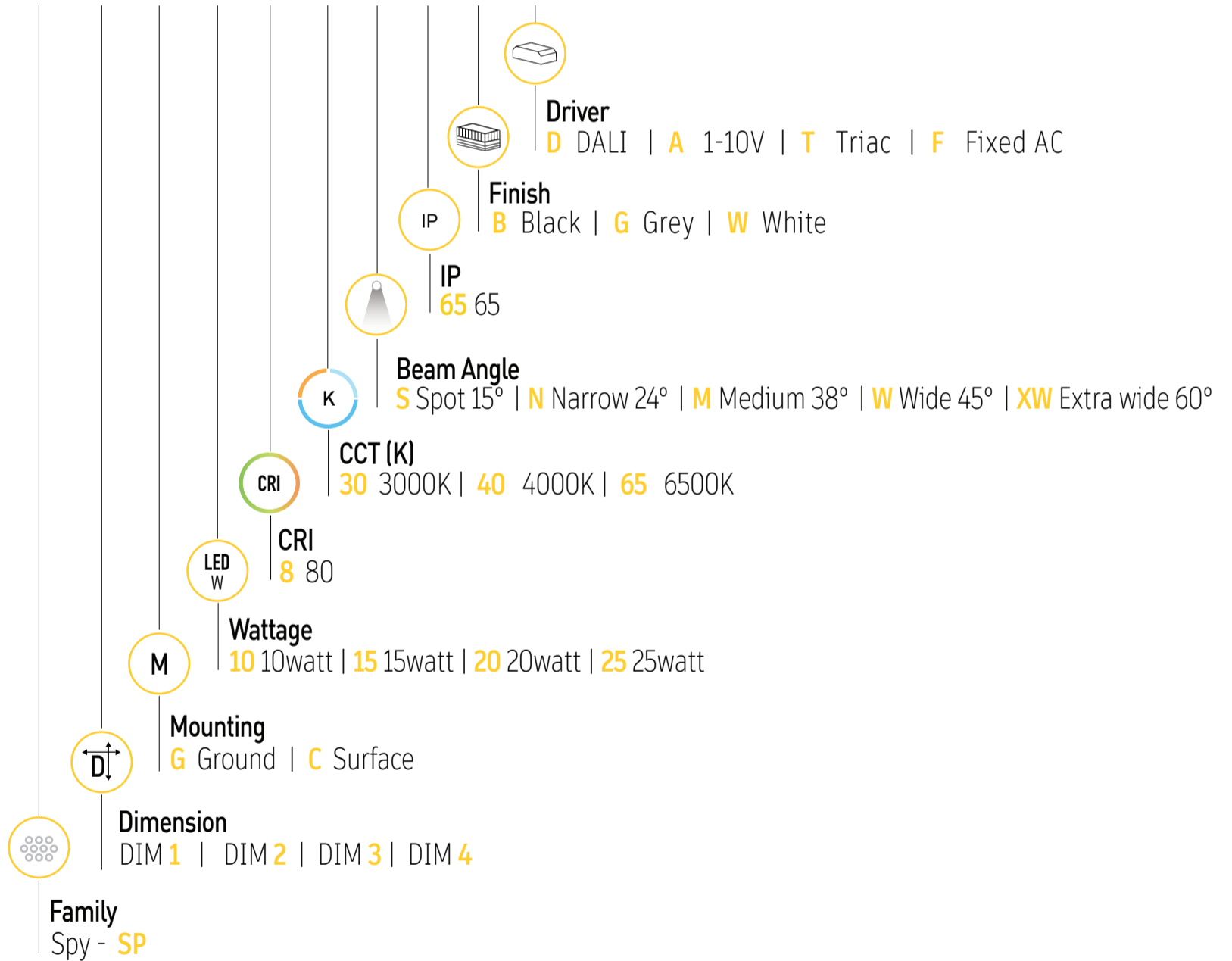

BR - SP X X XX.8 XX X 65 X - X

Configure luminaire specs & send us the code for order confirmation

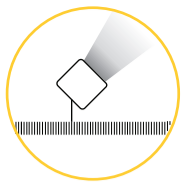

Optional Application



RGB



Dimmable

Brighton luminaires Map

■ Brighton Luminaires Range

■ Selected Luminaire Default placement

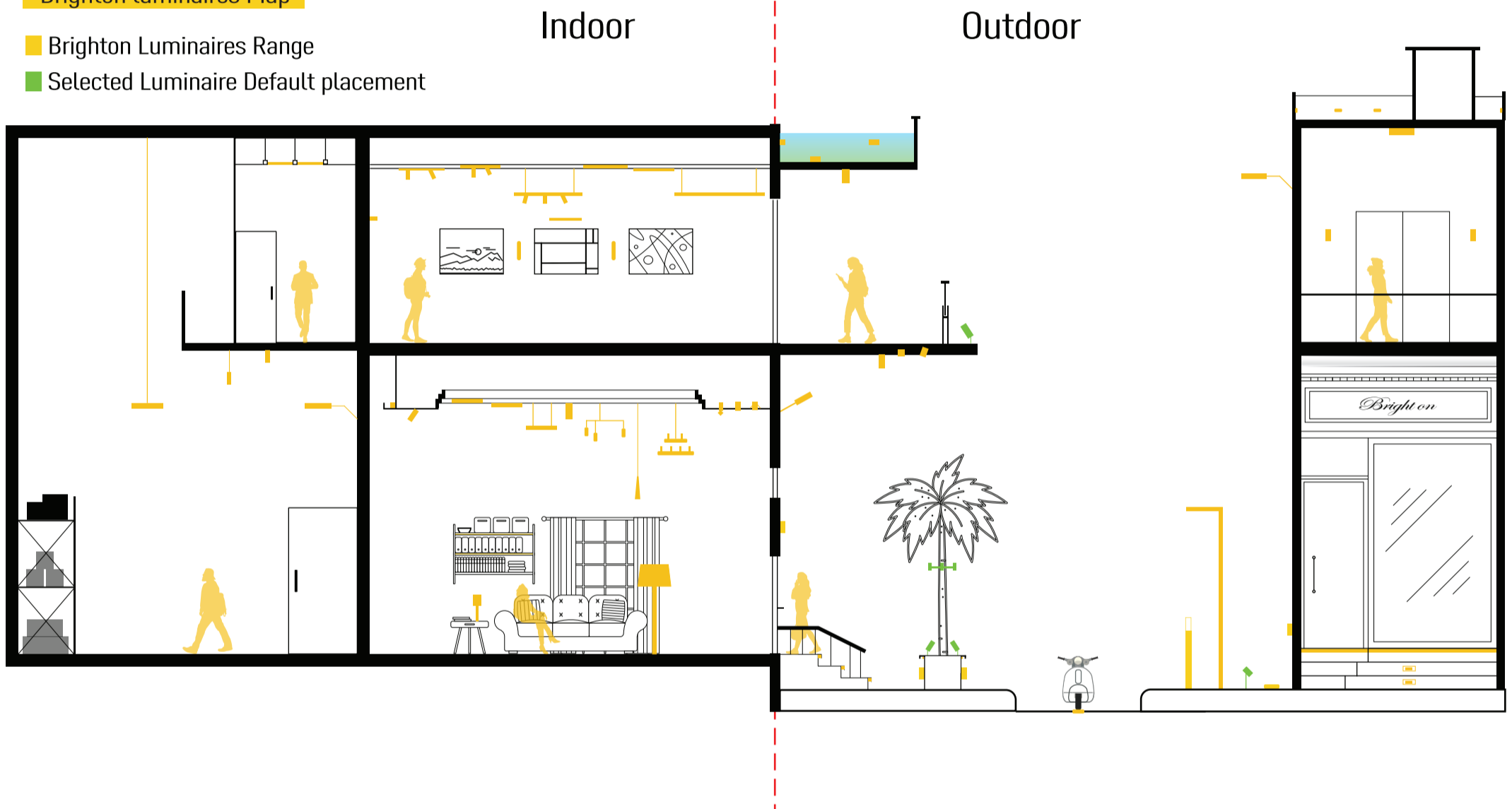

Accessories



01. Spike for garden application



02. Anti glare asymmetric snoot

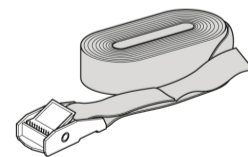

03. Tree Belt

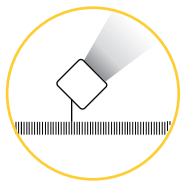

20 Watt 15° Beam Angle
Polar Curve

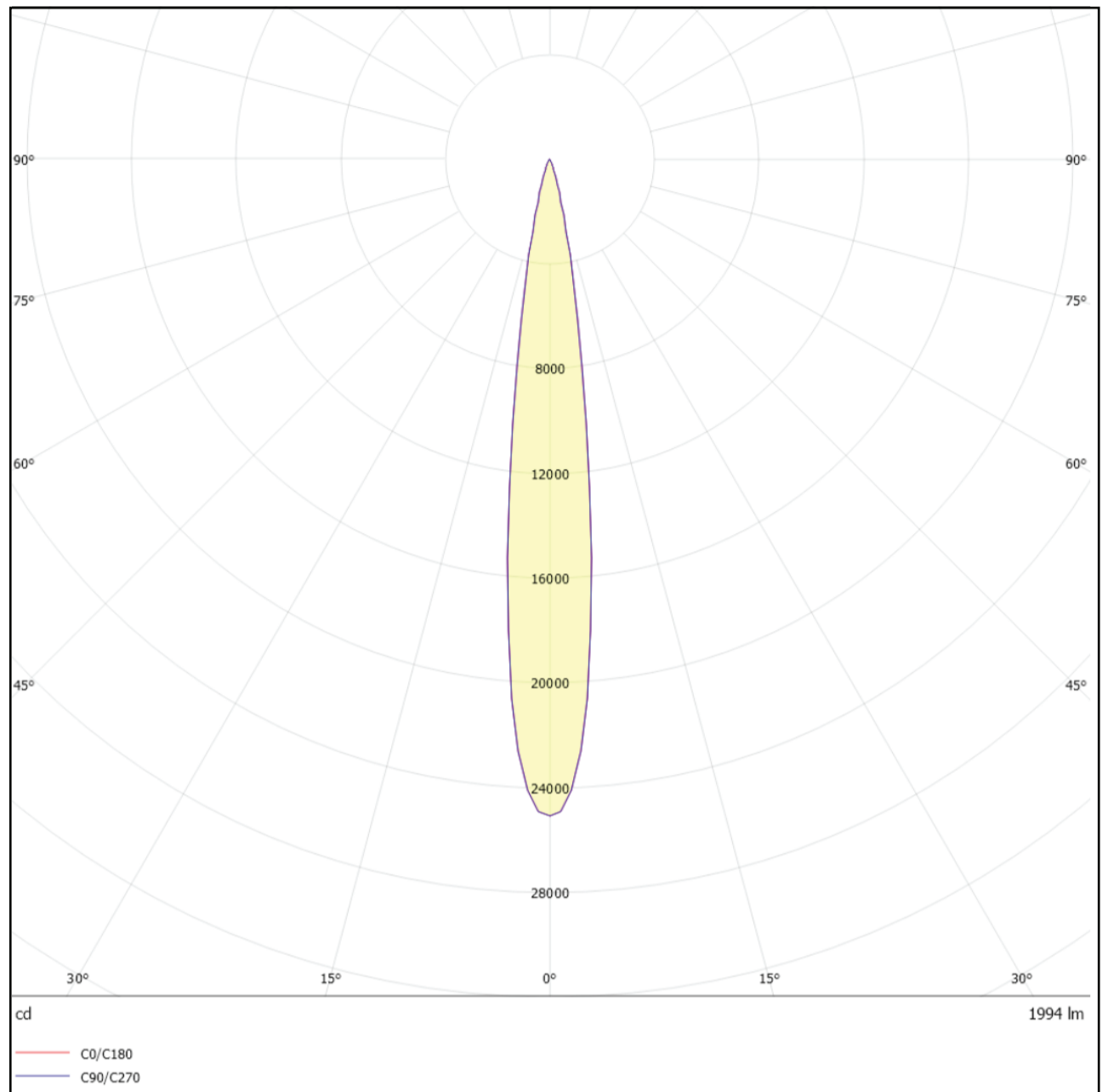

20 Watt 15° Beam Angle
Cone Diagram

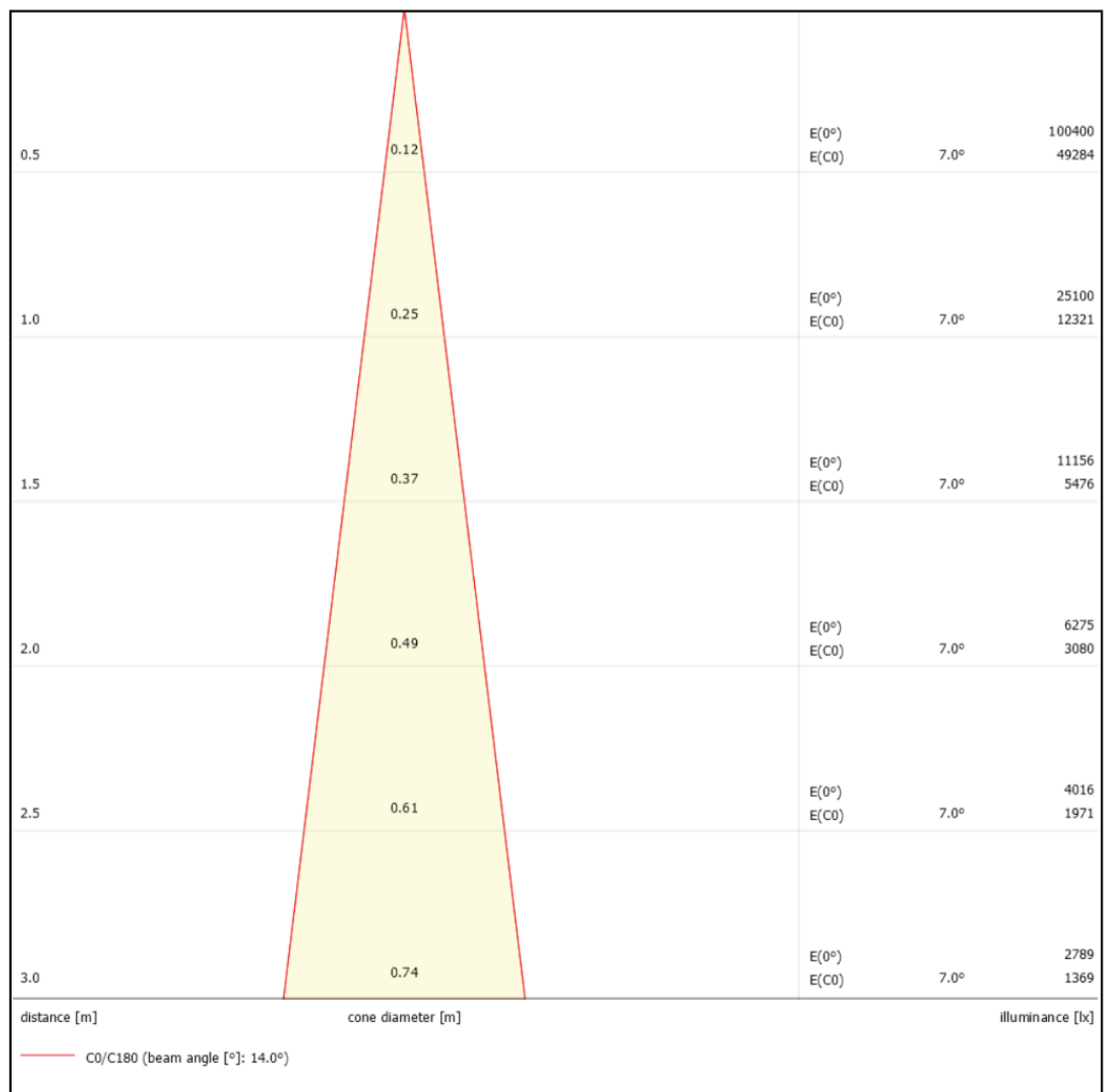

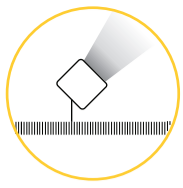

20 Watt 24° Beam Angle
Polar Curve

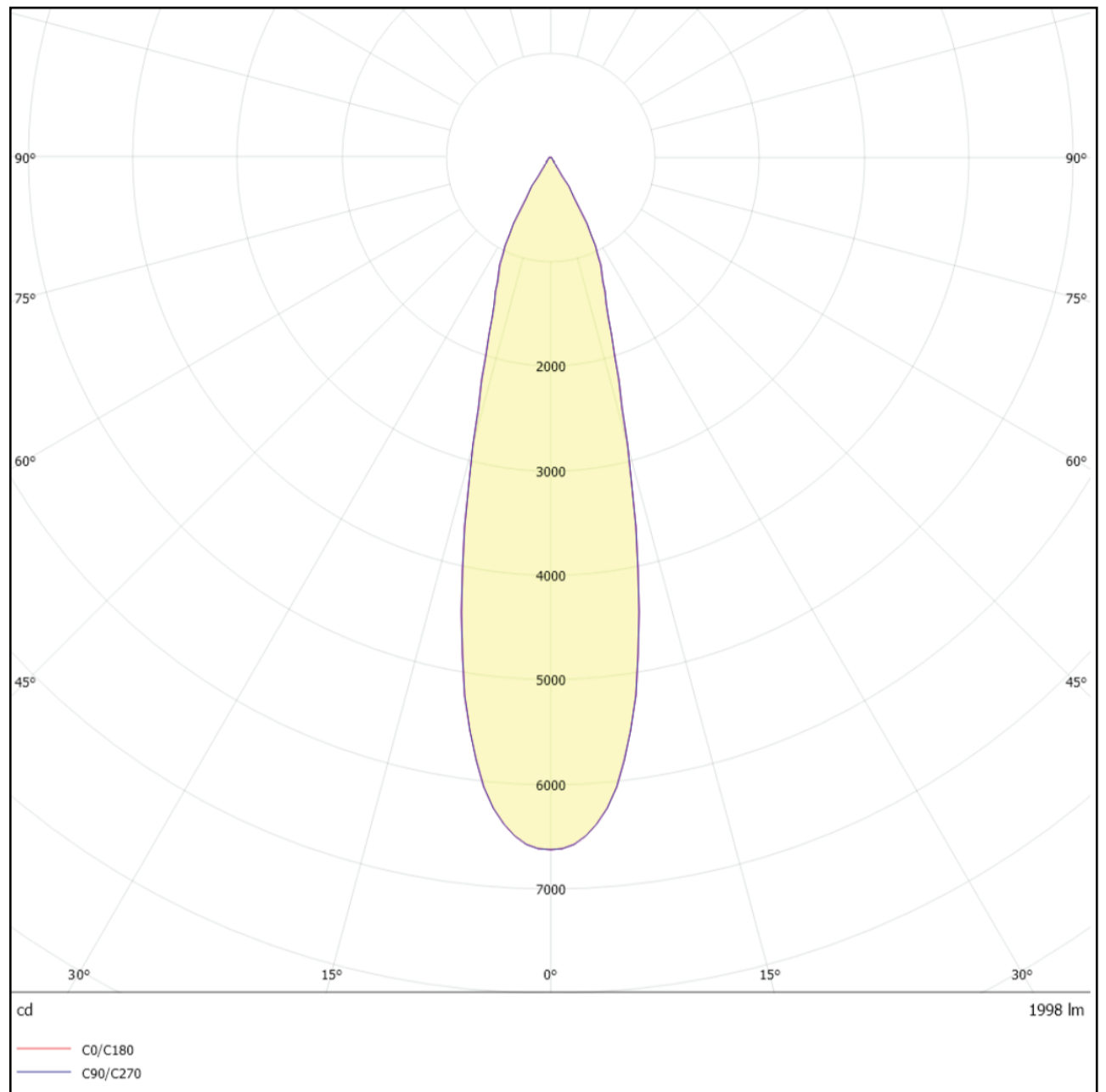

20 Watt 24° Beam Angle
Cone Diagram

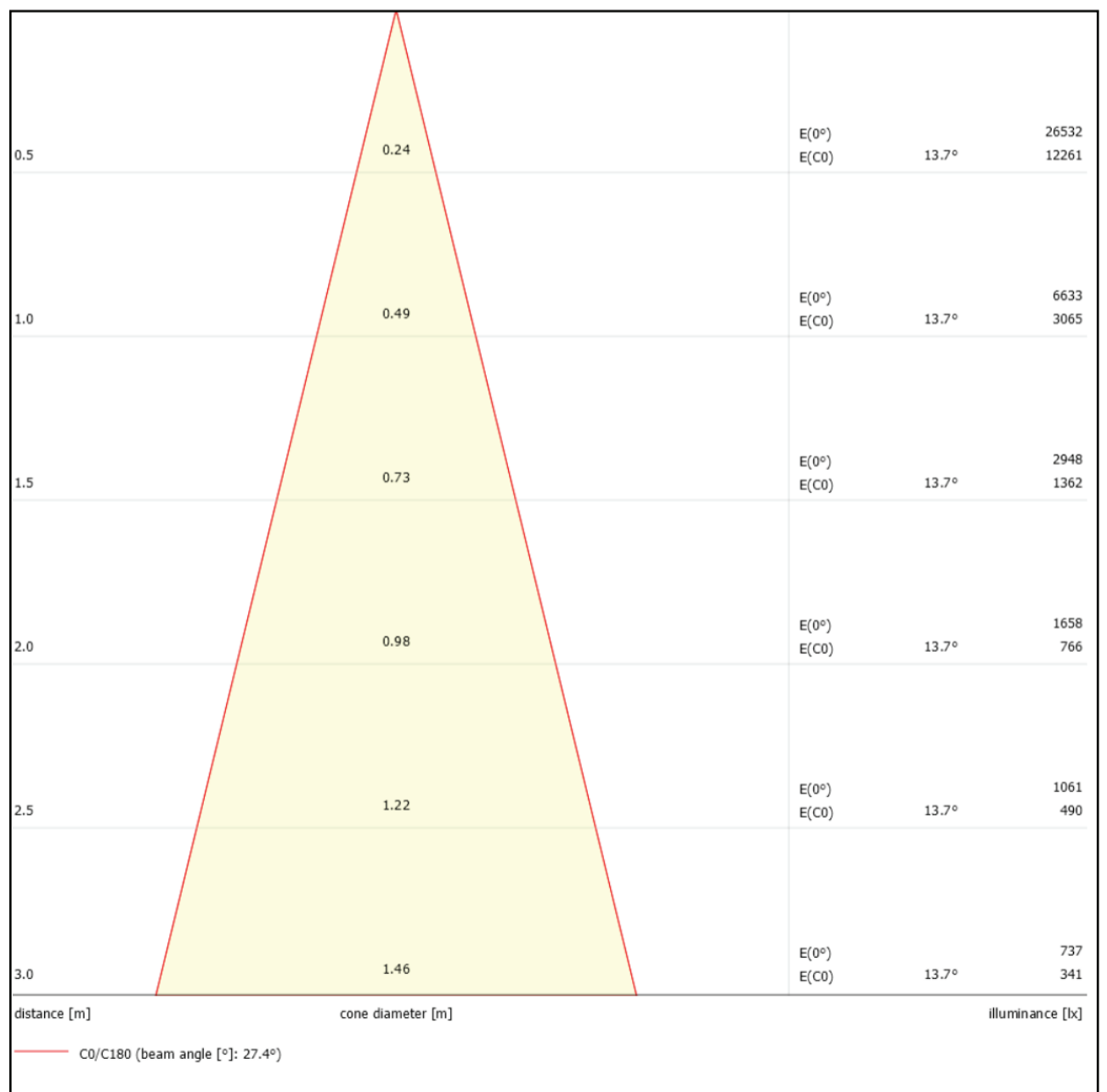

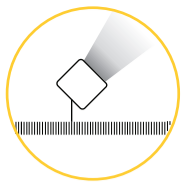

20 Watt 38° Beam Angle
Polar Curve

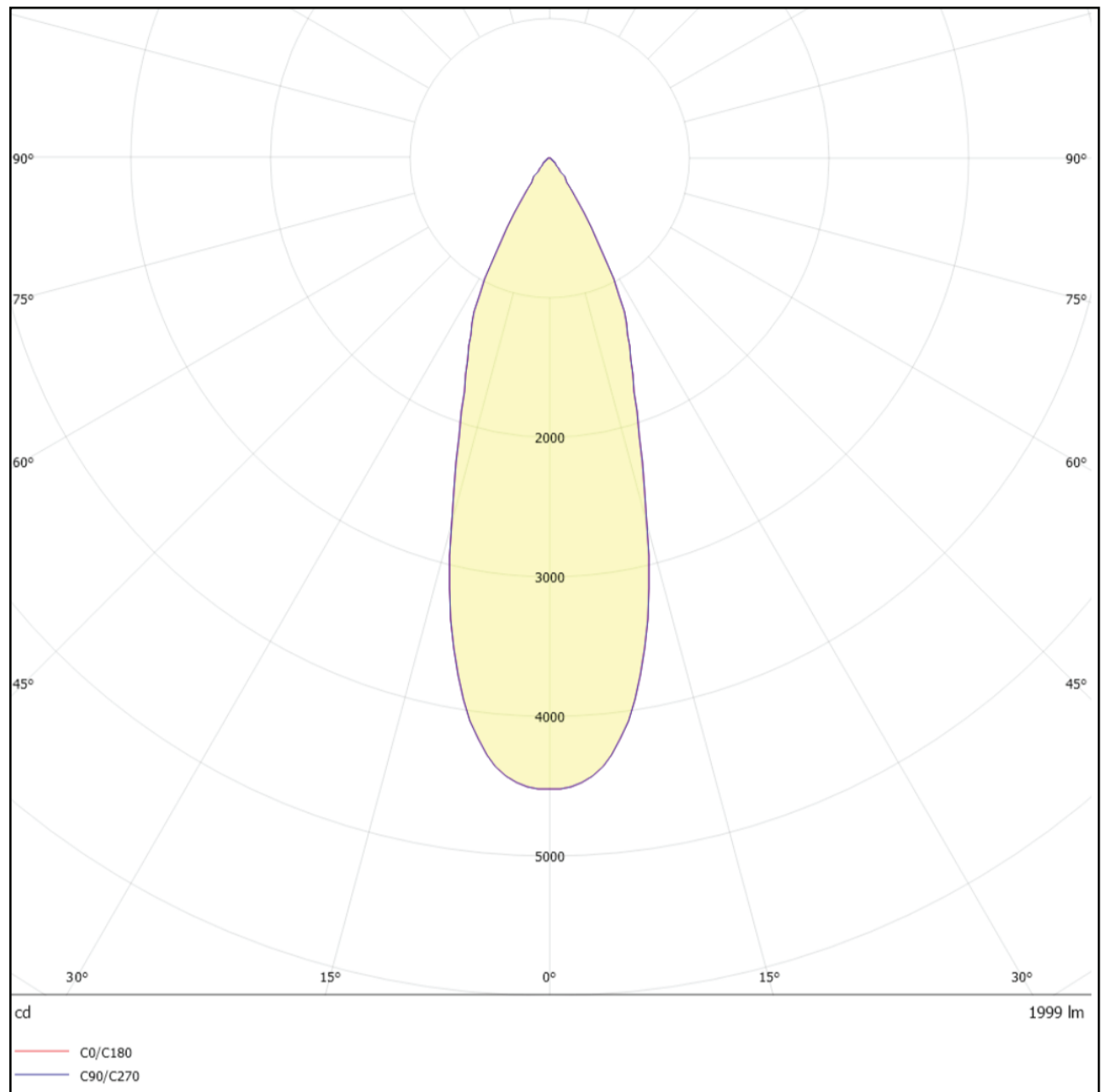

20 Watt 38° Beam Angle
Cone Diagram

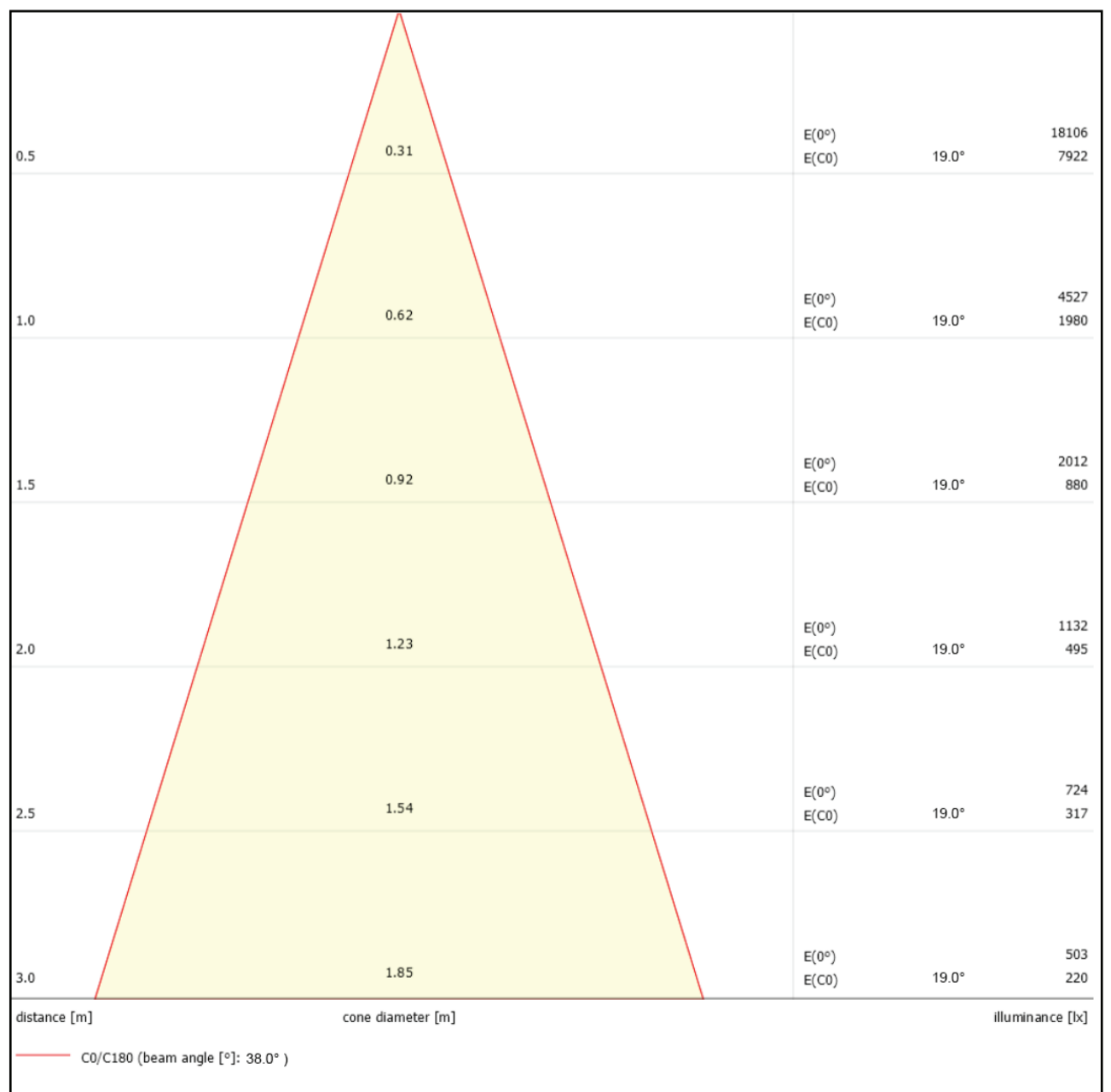

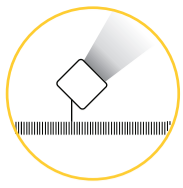

20 Watt 45° Beam Angle
Polar Curve

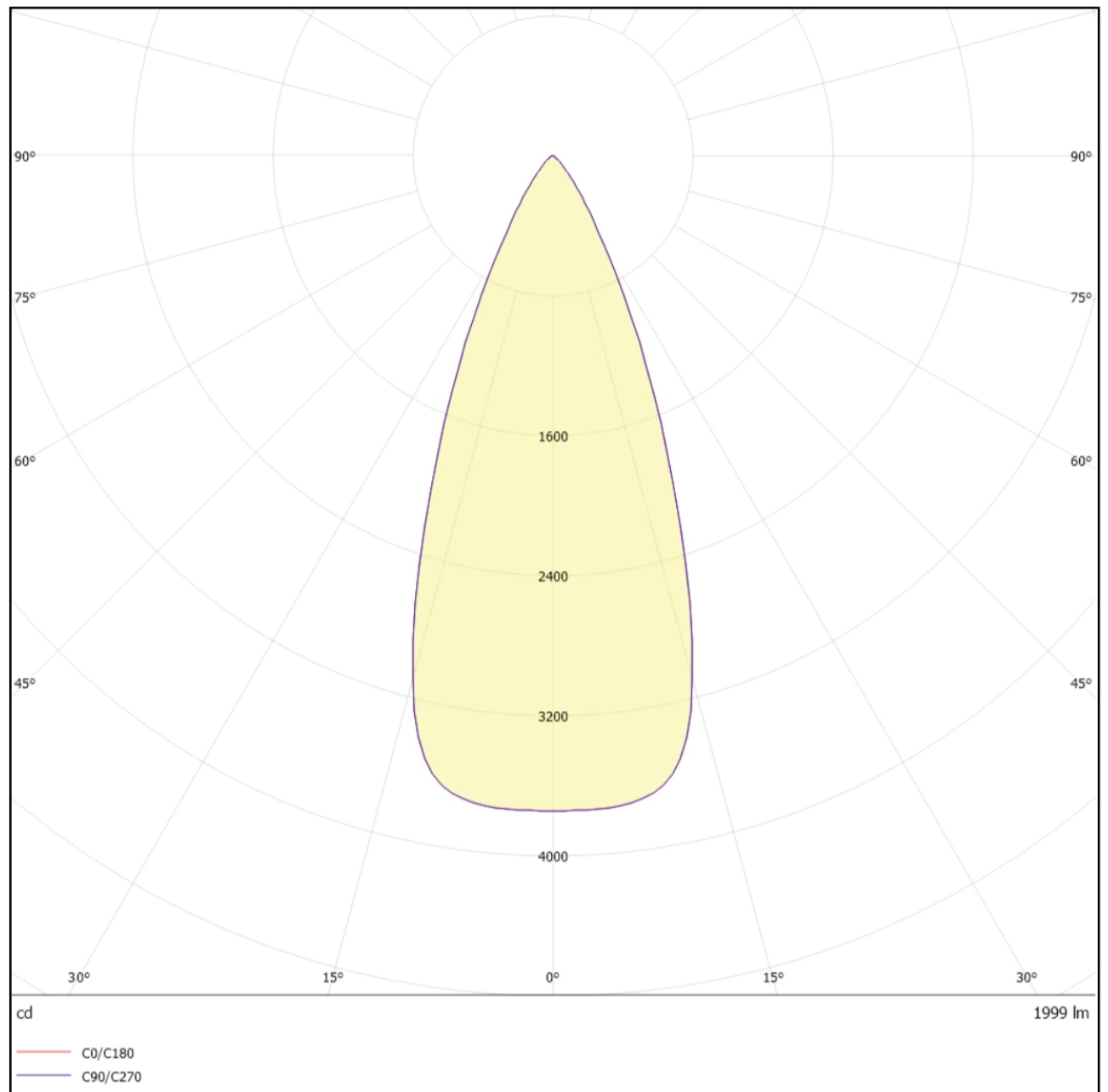

20 Watt 45° Beam Angle
Cone Diagram

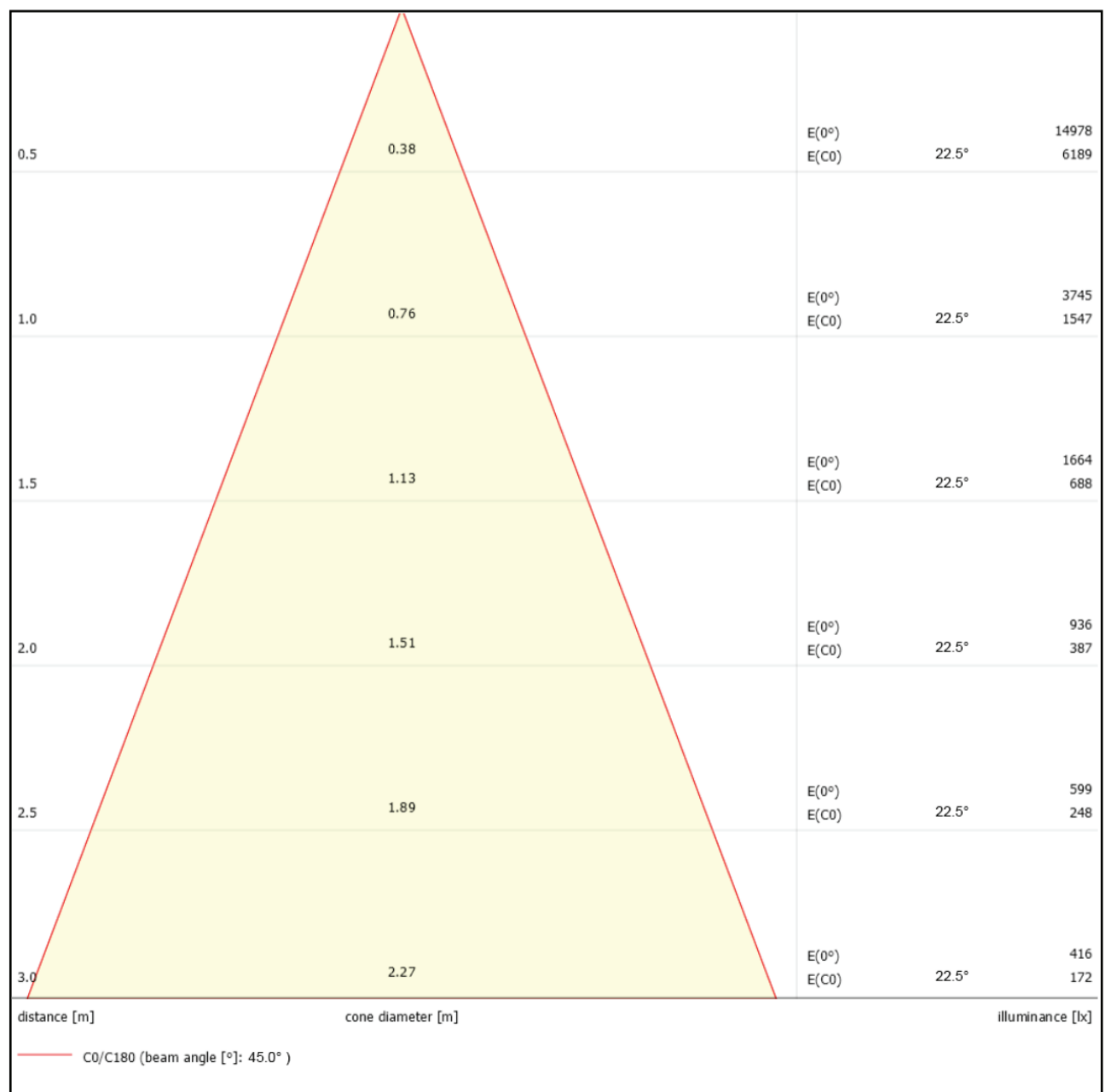

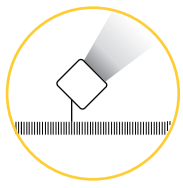

20 Watt 60° Beam Angle
Polar Curve

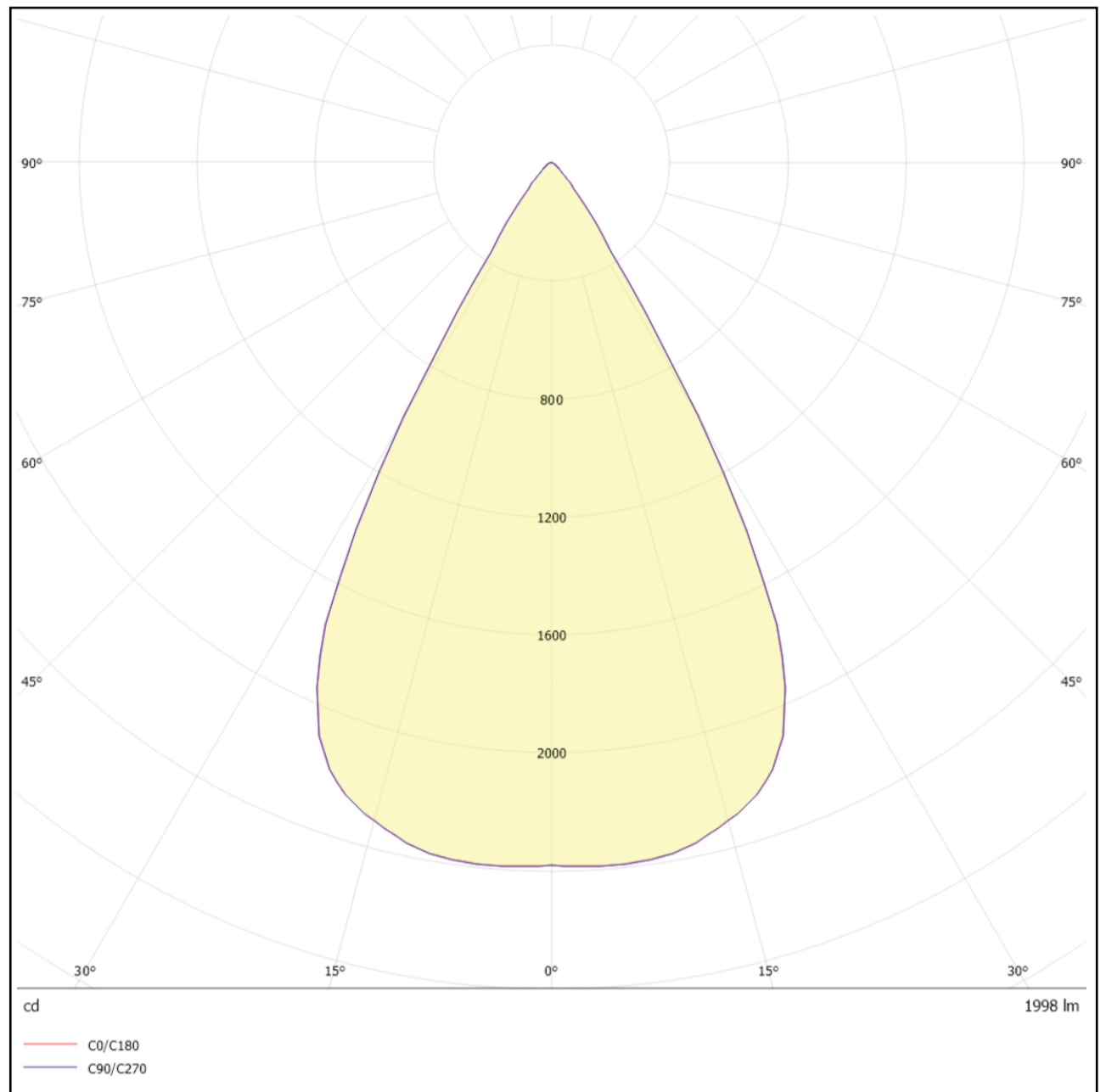

20 Watt 60° Beam Angle
Cone Diagram

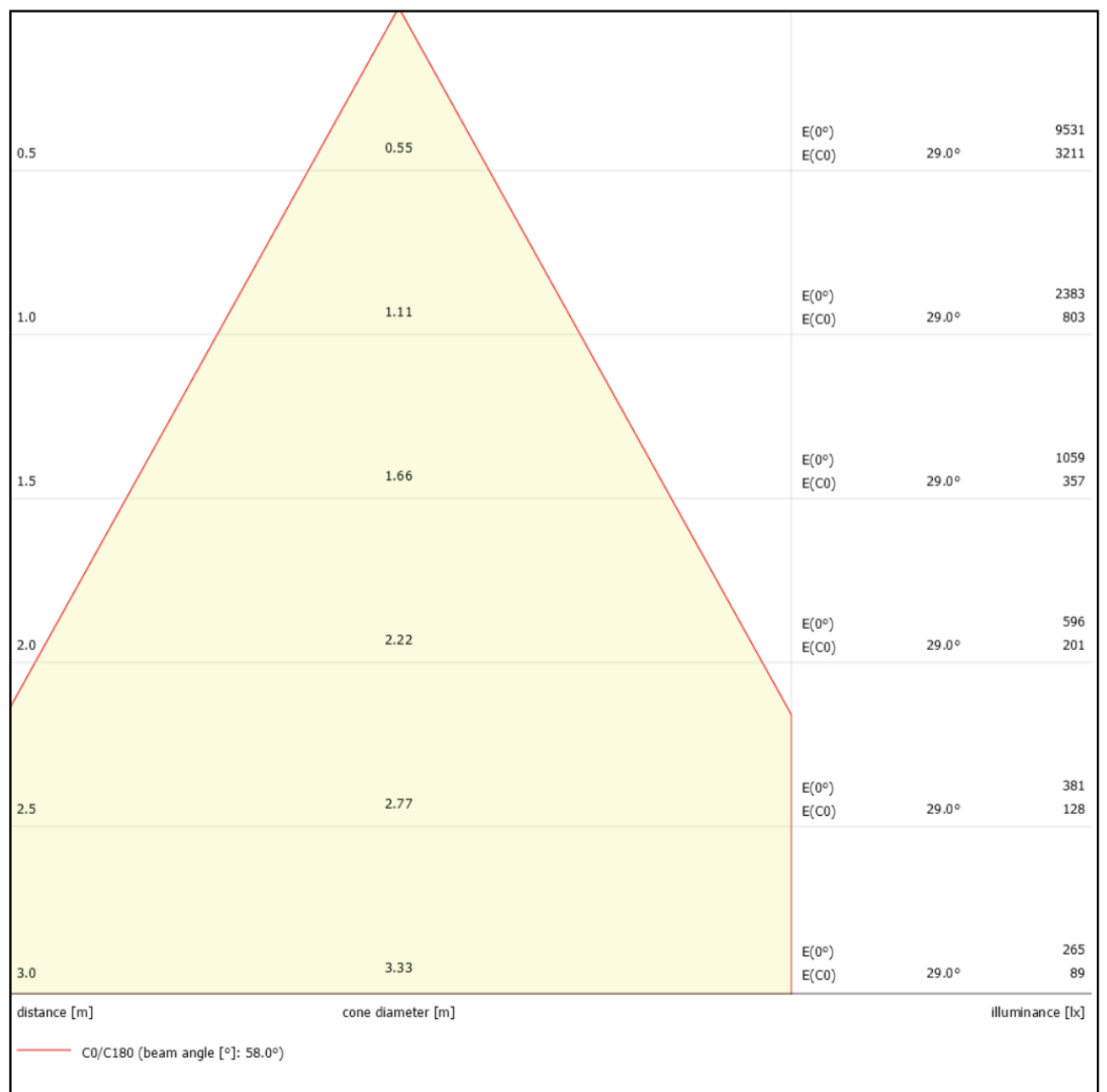



Spy SP

BRIGHTON