

## DESCRIPTION

Polo is designed for urban area environments, with specific optics for parking places, squares, walking areas, and cycling paths. The light distribution is completely directed downward, to provide an optimal distribution, with DALI power supply to manage the amount of light.



Driver



LED Chip



## Illumination Data

<b>Color temperature:</b>	3000K   4000K   5000K   6500K
<b>Lumen output:</b>	4050 LM   5400LM   6750LM   8100LM 9450 LM
<b>CRI</b>	80
<b>Beam angle</b>	95° Flood

## Physical Specification

<b>Material Finish</b>	Die cast aluminium
<b>Diffuser</b>	Poly carbonate
<b>Optics</b>	LENS
<b>Ingress protection (IP)</b>	65
<b>Impact Protection (IK)</b>	10

## Electric Characteristics

<b>Light source</b>	LED Built in
<b>LED type</b>	SMD
<b>Power</b>	30 Watt   40 Watt   50 Watt   60Watt 70 Watt
<b>P.F</b>	>0.9
<b>LED chip</b>	Lumileds
<b>Driver</b>	Meanwell

## Installation

<b>Installation</b>	Post top
<b>Wiring</b>	Product complete with electronic components

## Luminaire Body Finish Color

<b>Black Ral 9005</b>	
<b>Grey Ral 9006</b>	

## Certificate & Warranty

<b>Certification</b>	CB   CE   LM79   LM80 TM21   Photo biological
<b>Lifetime expectancy</b>	50.000 hrs
<b>Warranty duration</b>	Up to 5 years

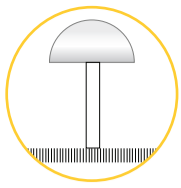

# Polo

Lighting Pole

## Dimensions & Specs

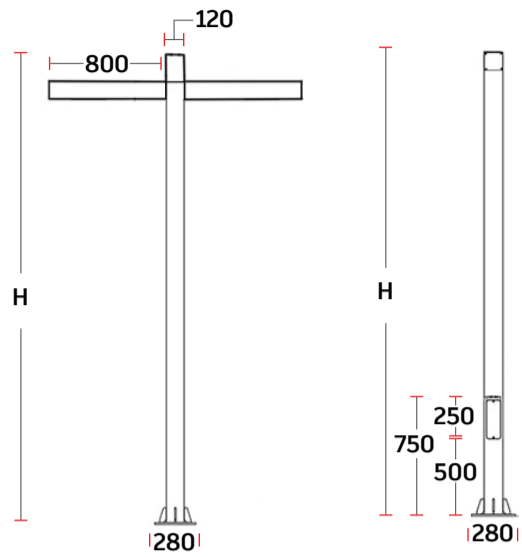

\*All dimensions in these sketches are in millimeters\*

## Dimensions of luminaires

Dim	W	L	H
1	120mm	120mm	1000mm
2	120mm	120mm	2000mm
3	120mm	120mm	3000mm
4	120mm	120mm	4000mm

## Specs

Wattage (W)	lumen (lm)
30 watt	4050lm
40 watt	5400lm
50 watt	6750lm
60 watt	8100lm
70 watt	9450lm

\*All dimensions in this schedule table are in millimeters\*

## Product coding system

BR - PO X P XX.8 XX F 65 X - X

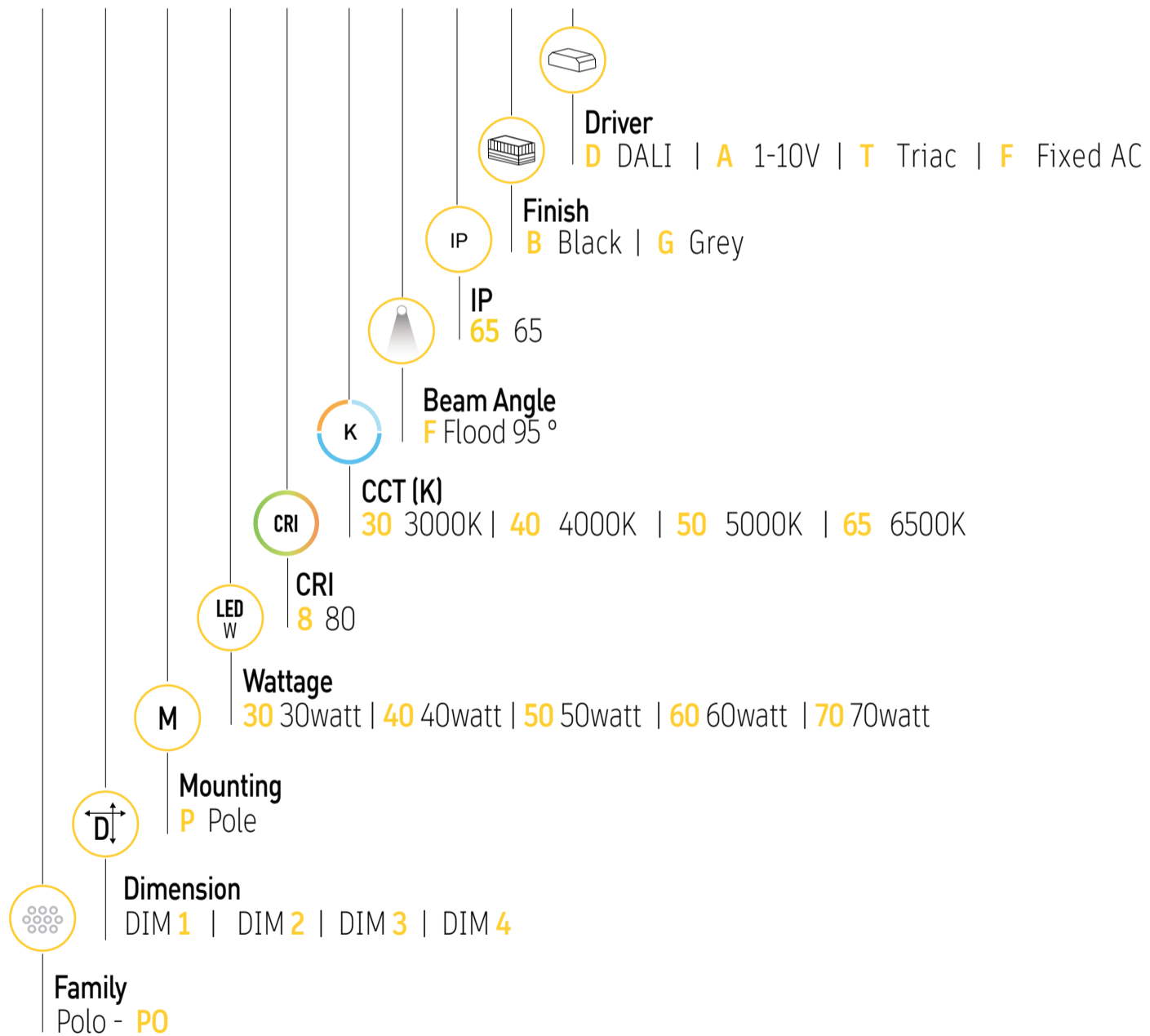

BR - PO X P XX.8 XX F 65 X - X

Configure luminaire specs & send us the code for order confirmation

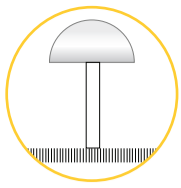

# Polo

Lighting Pole

## Optional Application



Dimmable

## Brighton luminaires Map

Brighton Luminaires Range

Selected Luminaire Default placement

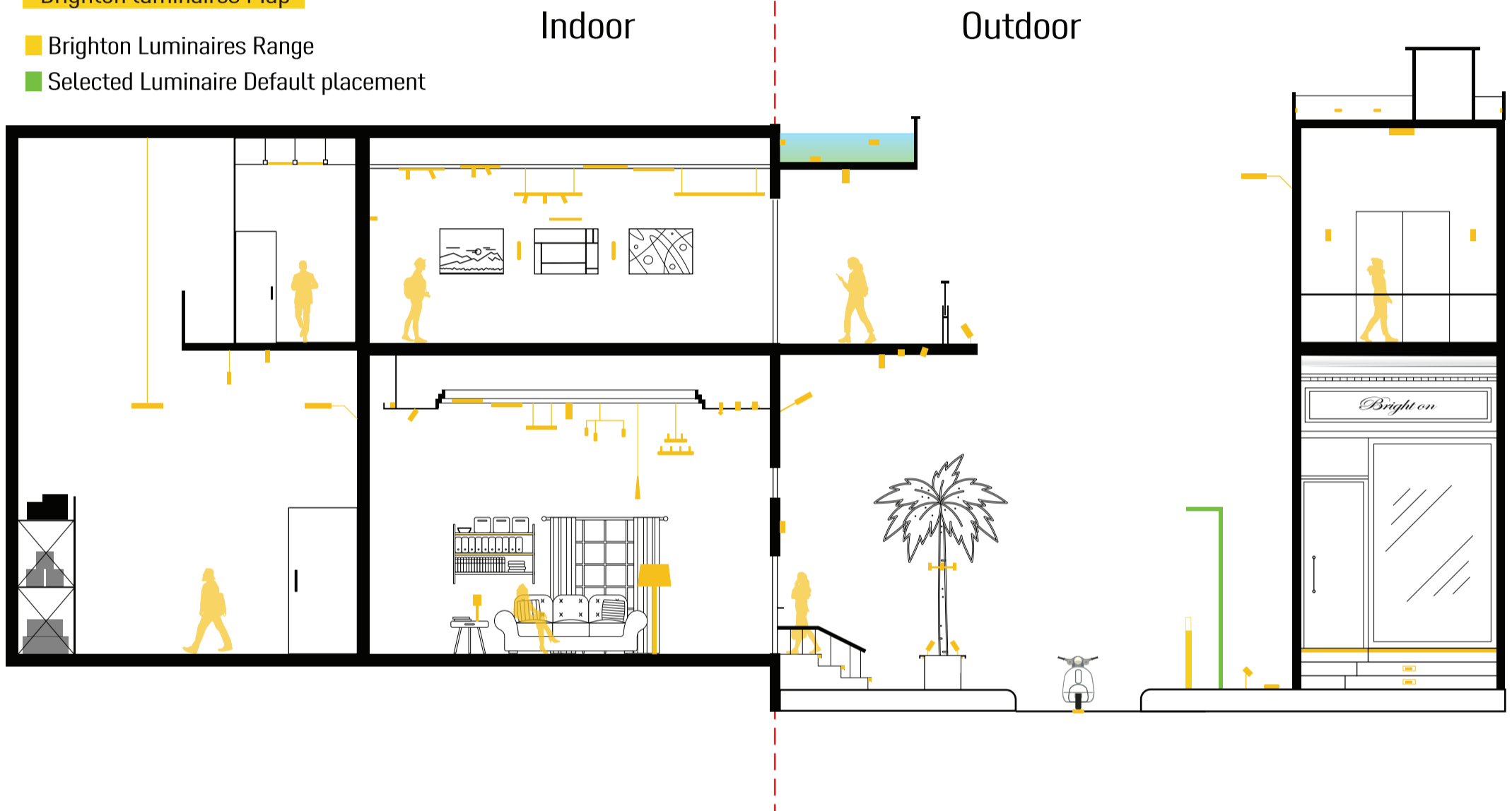

## Accessories

01. Square Anchor Bolt



02. Round Anchor Bolt



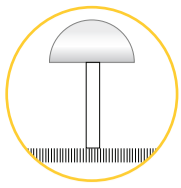

50 Watt 95° Flood  
Polar curve

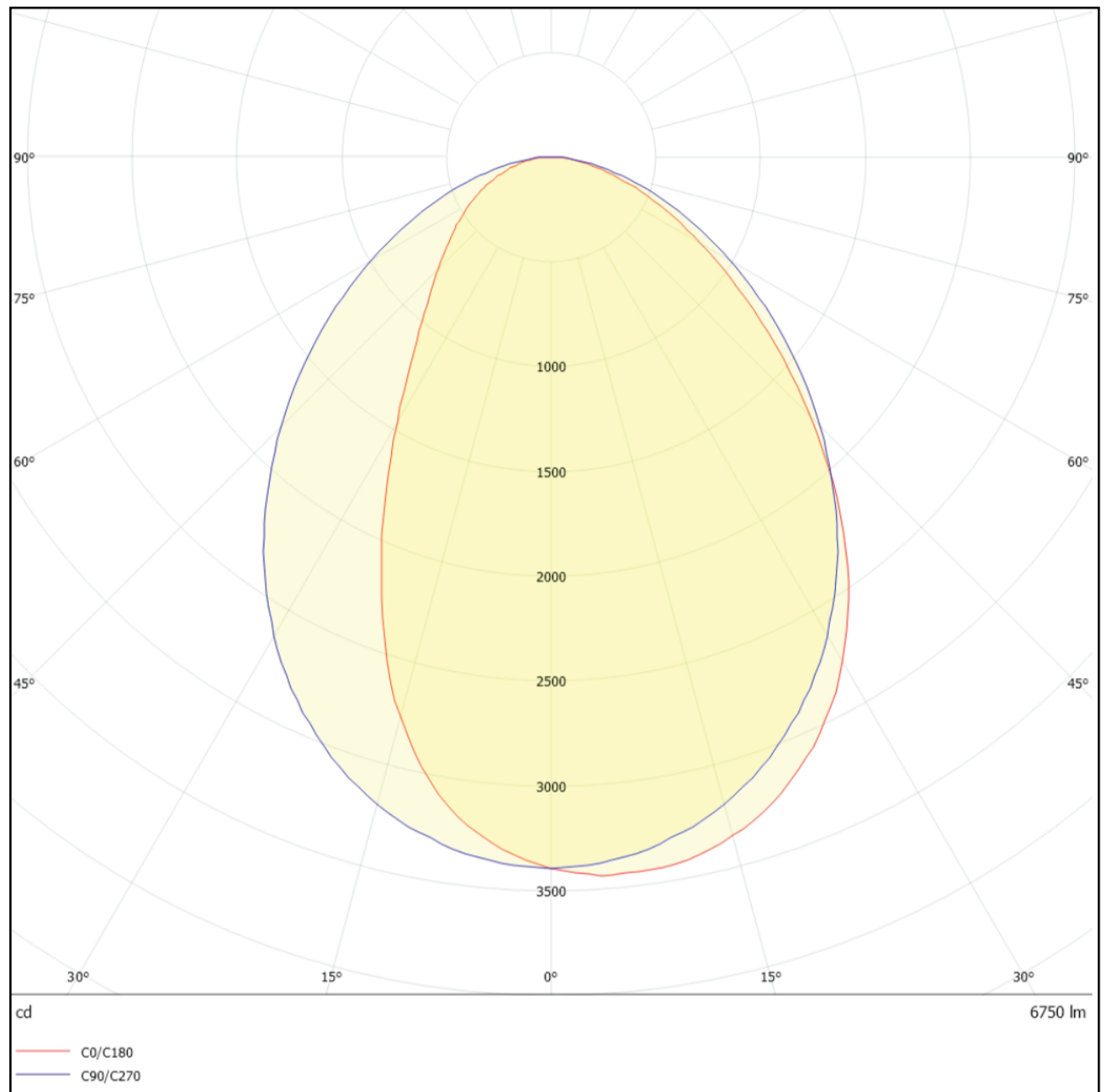

50 Watt 95° Flood  
Cone Diagram

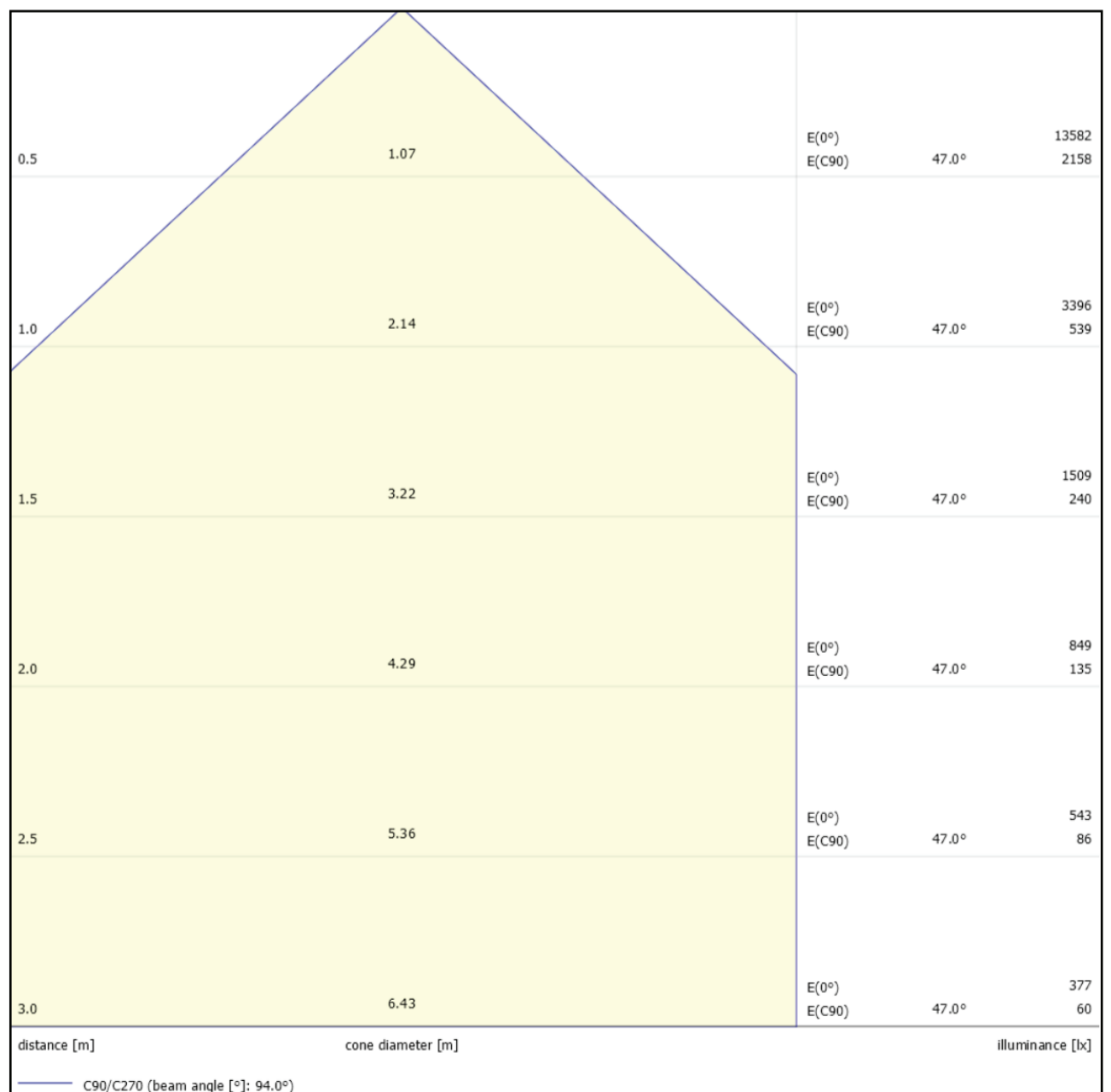

Polo PO

BRIGHTON

